

5SET 0540T1800

Phase control thyristor module



- Insulated baseplate by AlN ceramic
- Precision pressure contacts for high reliability
- Industry standard housing

Applications

- Controlled line frequency bridge arm
- AC motor soft starters
- DC motor drives

Key parameters

- $V_{DRM}, V_{RRM} = 1800 \text{ V}$
- $I_{TAVm} = 542 \text{ A}$
- $I_{TSM} = 14\,000 \text{ A}$
- $V_{TO} = 0.845 \text{ V}$
- $r_T = 0.380 \text{ m}\Omega$

Types

	V_{RRM}
5SET 0540T1800	1 800 V
Conditions	$T_j = -40 \div 135 \text{ }^\circ\text{C}$, half sine waveform, $f = 50 \text{ Hz}$, note 1

Mechanical data

M_s	Mounting torque (base - heatsink)	$6 \pm 15 \%$	Nm
M_t	Mounting torque (main terminals)	$12 \pm 15 \%$	Nm
m	Weight	1.4	kg
a	Acceleration resistance	50	m/s^2
UL recognized, file no.		E500543	

Fig. 1 Case

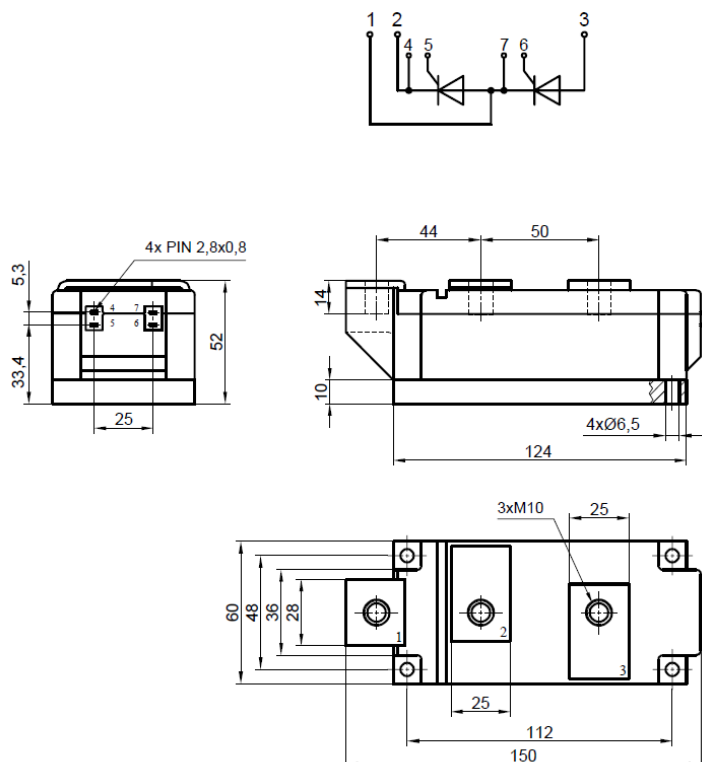

Maximum ratings		Maximum limits	Unit
V_{DRM}, V_{RRM}	Repetitive peak reverse and off-state voltage $T_j = -40 \div 135 \text{ }^\circ\text{C}$, note 1	1800	V
I_{DM}	Peak off-state current $V_D = V_{DRM}$	100	mA
I_{RM}	Peak reverse current $V_R = V_{RRM}$	100	mA
I_{TAVm}	Average on-state current half sine waveform, $f = 50 \text{ Hz}$	$T_c = 70 \text{ }^\circ\text{C}$	654
		$T_c = 85 \text{ }^\circ\text{C}$	542
		$T_c = 100 \text{ }^\circ\text{C}$	416
I_{TRMS}	RMS on-state current half sine waveform, $f = 50 \text{ Hz}$	$T_c = 70 \text{ }^\circ\text{C}$	1028
		$T_c = 85 \text{ }^\circ\text{C}$	852
		$T_c = 100 \text{ }^\circ\text{C}$	654
I_{TSM}	Non repetitive peak surge current half sine pulse, $V_D = V_R = 0 \text{ V}$	$t_p = 8.3 \text{ ms}$	15,000
		$t_p = 10 \text{ ms}$	14,000
I^2t	Limiting load integral half sine pulse, $V_D = V_R = 0 \text{ V}$	$t_p = 8.3 \text{ ms}$	928,000
		$t_p = 10 \text{ ms}$	980,000
$(di_T/dt)_{cr}$	Critical rate of rise of on-state current $I_T = I_{TAVm}$, half sine waveform, $f = 50 \text{ Hz}$, $V_D = 2/3 V_{DRM}$, $t_r = 0.3 \text{ } \mu\text{s}$, $I_{GT} = 2 \text{ A}$	200	A/ μs
$(dv_D/dt)_{cr}$	Critical rate of rise of off-state voltage $V_D = 2/3 V_{DRM}$	1000	V/ μs
P_{GAVm}	Maximum average gate power losses	3	W
I_{FGM}	Peak gate current	10	A
V_{FGM}	Peak gate voltage	12	V
V_{RGM}	Reverse peak gate voltage	10	V
$T_{jmin} - T_{jmax}$	Operating temperature range	-40 \div 135	$^\circ\text{C}$
T_{STG}	Storage temperature range	-40 \div 125	

Unless otherwise specified $T_j = 135 \text{ }^\circ\text{C}$

Note 1: De-rating factor of 0.13% VRRM or VDRM per $^\circ\text{C}$ is applicable for T_j below $25 \text{ }^\circ\text{C}$

Insulation characteristics	Value			Unit
	min	typ	max	
V_{ISOL}	Isolation voltage (base – terminals) RMS, sine waveform, $f = 50 \text{ Hz}$, $T_j = 25 \text{ }^\circ\text{C}$, $t = 1 \text{ min}$			V
			3600	

STATUS	SECURITY LEVEL	DOCUMENT ID	REV.	LANG.	PAGE
Preliminary datasheet	Public	5SET 0540T1800, TS - MT/338/19 Jun-21	A	en	2/7

On-state characteristics		Value			Unit
		min	typ	max	
V_{T0}	Threshold voltage			0.845	V
r_T	Slope resistance $I_{T1} = 848 \text{ A}$, $I_{T2} = 2545 \text{ A}$			0.380	m Ω
V_{TM}	Maximum peak on-state voltage	$I_{TM} = 1\,000 \text{ A}$		1.230	V
		$I_{TM} = 1\,500 \text{ A}$		1.440	

Unless otherwise specified $T_j = 135 \text{ }^\circ\text{C}$

Characteristics		Value			Unit
		min	typ	max	
t_{gd}	Delay time $T_j = 25 \text{ }^\circ\text{C}$, $V_D = 0.4 V_{DRM}$, $I_{TM} = I_{TAVm}$, $t_r = 0.3 \mu\text{s}$, $I_{GT} = 2 \text{ A}$			2.0	μs
t_q	Turn-off time $I_T = 1\,000 \text{ A}$, $di_T/dt = -10 \text{ A}/\mu\text{s}$, $V_R = 100 \text{ V}$, $V_D = 2/3 V_{DRM}$, $dv_D/dt = 50 \text{ V}/\mu\text{s}$			250	μs
Q_{rr}	Recovered charge the same conditions as at t_q			2000	μC
I_{rrM}	Reverse recovery maximum current the same conditions as at t_q			160	A
I_H	Holding current	$T_j = 25 \text{ }^\circ\text{C}$		150	mA
		$T_j = 135 \text{ }^\circ\text{C}$		100	
I_L	Latching current	$T_j = 25 \text{ }^\circ\text{C}$		400	mA
		$T_j = 135 \text{ }^\circ\text{C}$		350	
V_{GT}	Gate trigger voltage $V_D = 12\text{V}$, $I_T = 4 \text{ A}$	$T_j = -40 \text{ }^\circ\text{C}$		4	V
		$T_j = 25 \text{ }^\circ\text{C}$		3	
		$T_j = 135 \text{ }^\circ\text{C}$	0.25	2	
I_{GT}	Gate trigger current $V_D = 12\text{V}$, $I_T = 4 \text{ A}$	$T_j = -40 \text{ }^\circ\text{C}$		1000	mA
		$T_j = 25 \text{ }^\circ\text{C}$		500	
		$T_j = 135 \text{ }^\circ\text{C}$	10	300	

Unless otherwise specified $T_j = 135 \text{ }^\circ\text{C}$

STATUS Preliminary datasheet	SECURITY LEVEL Public	DOCUMENT ID 5SET 0540T1800, TS - MT/338/19 Jun-21	REV. A	LANG. en	PAGE 3/7
---------------------------------	--------------------------	--	-----------	-------------	-------------

Thermal parameters			Value	Unit
R_{thjc}	Thermal resistance junction to case	per arm	65.0	K/kW
		per module	32.5	
R_{thch}	Thermal resistance case to heatsink	per arm	20.0	K/kW
		per module	10.0	

Transient thermal impedance

Analytical function for transient thermal impedance

$$Z_{thjc} = \sum_{i=1}^4 R_i (1 - \exp(-t/\tau_i))$$

i	1	2	3	4
τ_i (s)	3.40	0.60	0.10	0.01
R_i (K/kW)	23.00	22.00	13.70	6.30

Fig. 2 Dependence transient thermal impedance junction to case on square pulse

Correction for periodic waveforms

180°	sine	3.0	K/kW
120°	sine	4.7	K/kW
60°	sine	7.0	K/kW
180°	rectangular	4.8	K/kW
120°	rectangular	7.4	K/kW
60°	rectangular	12.0	K/kW

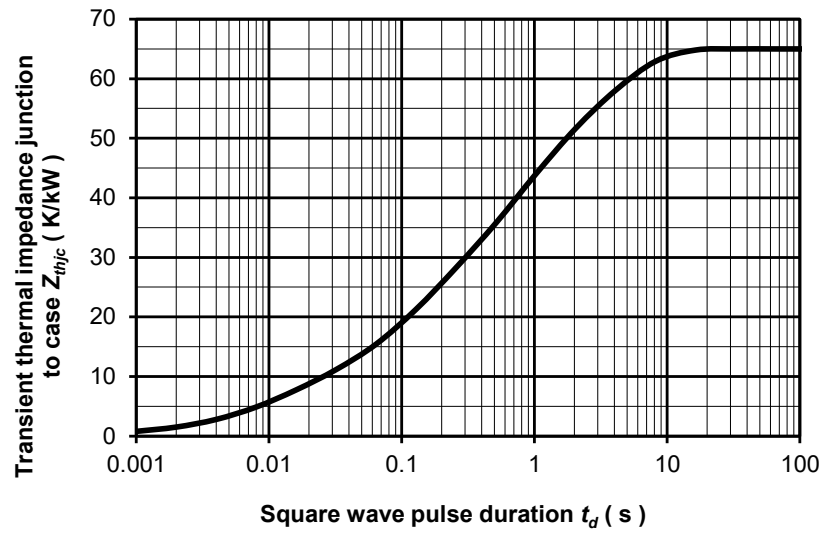

STATUS	SECURITY LEVEL	DOCUMENT ID	REV.	LANG.	PAGE
Preliminary datasheet	Public	5SET 0540T1800, TS - MT/338/19 Jun-21	A	en	4/7

On-state and surge characteristics

Fig. 3 Maximum on-state characteristics

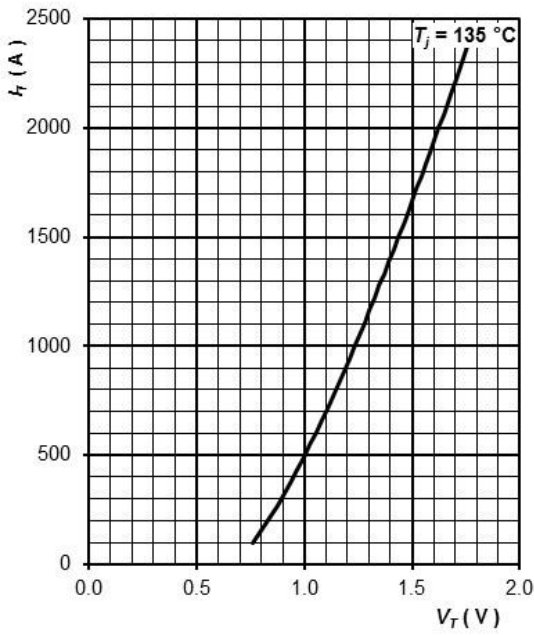
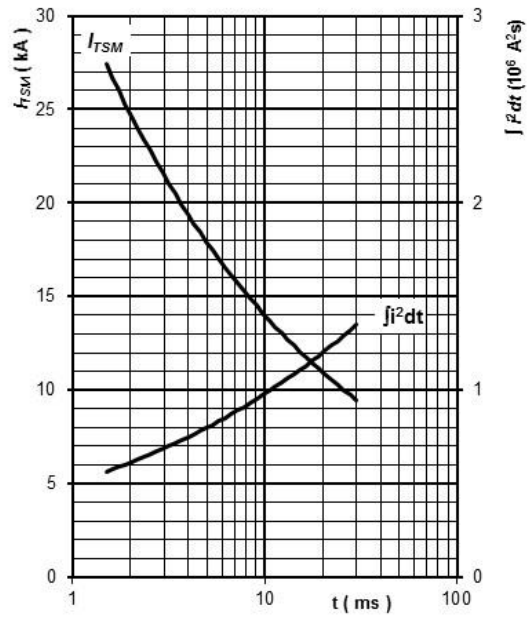

Fig. 4 Surge on-state current vs. pulse length, half sine wave, single pulse, $V_D = V_R = 0\text{ V}$, $T_j = T_{jmax}$



Gate trigger characteristics

Fig. 5 Gate trigger characteristics

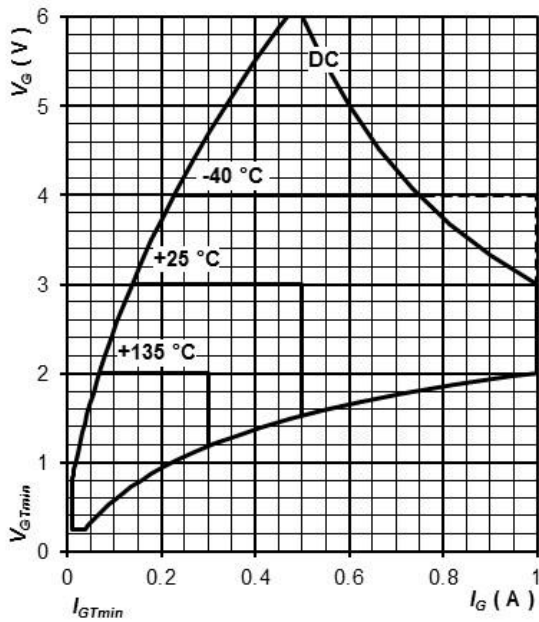
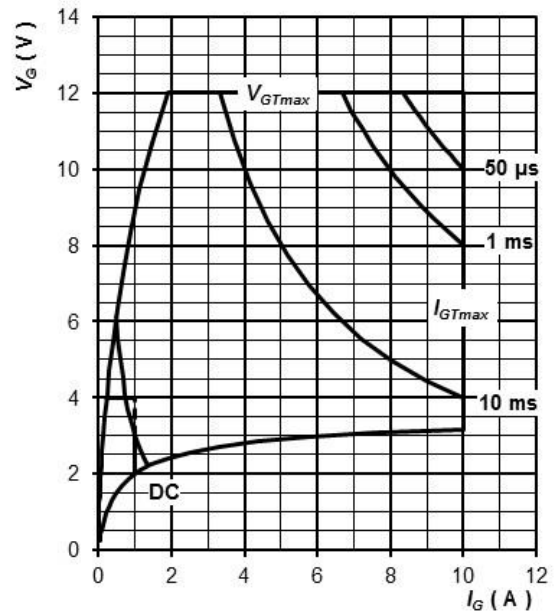

Fig. 6 Maximum peak gate power loss



Power loss and maximum case temperature characteristics per arm

Fig. 7 On-state power loss vs. average on-state current, sine waveform, $f = 50 \text{ Hz}$, $T = 1/f$

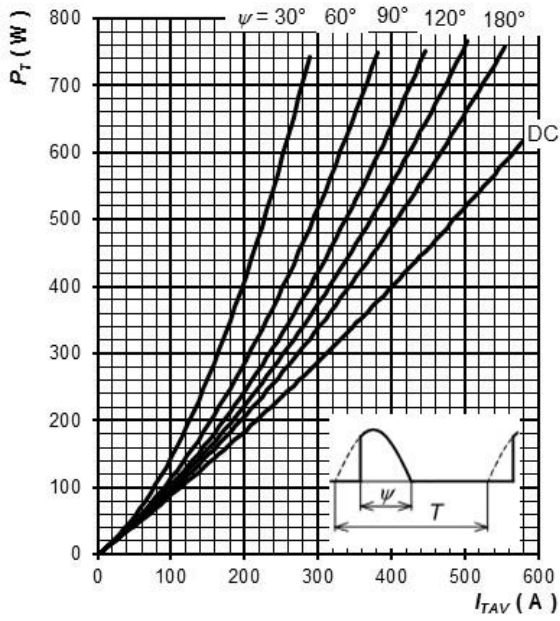

Fig. 8 On-state power loss vs. average on-state current, square waveform, $f = 50 \text{ Hz}$, $T = 1/f$

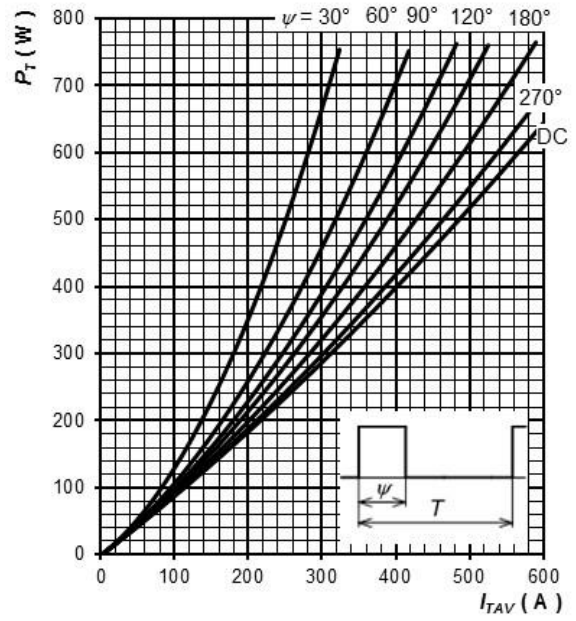

Fig. 9 Max. case temperature vs. aver. on-state current, sine waveform, $f = 50 \text{ Hz}$, $T = 1/f$

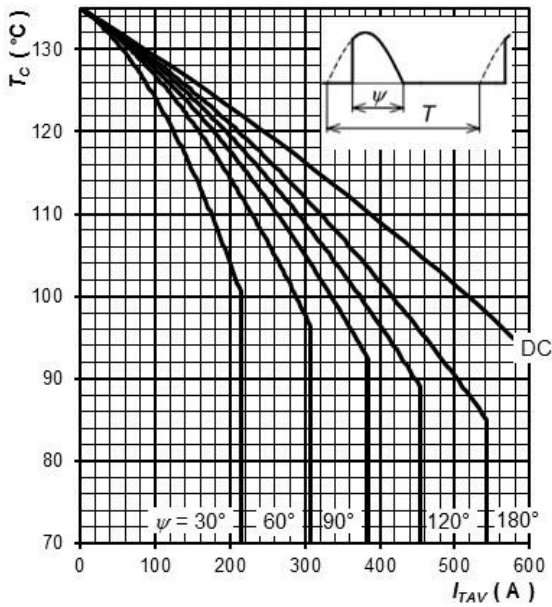
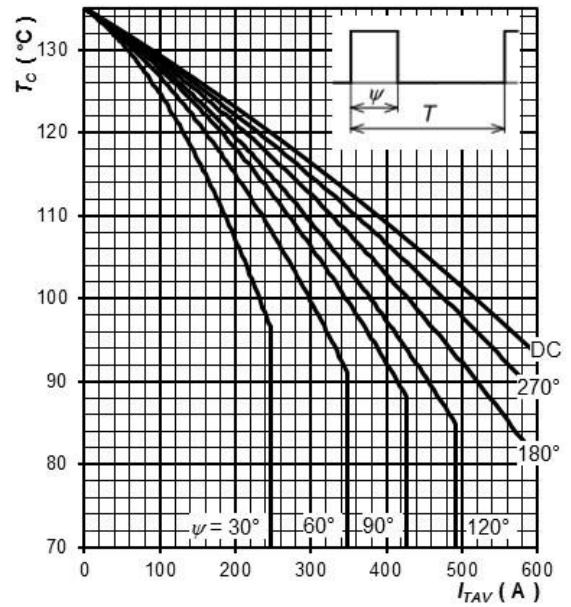

Fig. 10 Max. case temperature vs. aver. on-state current, square waveform, $f = 50 \text{ Hz}$, $T = 1/f$



Note 2: Figures number 7 - 10 have been calculated without considering any turn-on and turn-off losses. They are valid for $f = 50$ or 60 Hz operation.

STATUS	SECURITY LEVEL	DOCUMENT ID	REV.	LANG.	PAGE
Preliminary datasheet	Public	5SET 0540T1800, TS - MT/338/19 Jun-21	A	en	6/7

ABB Power Grids Czech Republic s.r.o.

A Hitachi ABB Joint Venture
Semiconductors
Novodvorska 1768/138a
142 21 Praha 4
Czech Republic

hitachiabb-powergrids.com/semiconductors

Note

We reserve all rights in this document and in the information contained therein. Reproduction use or disclosure to third parties without expressed authority is strictly forbidden. © 2021 Hitachi Power Grids. All rights reserved.

STATUS	SECURITY LEVEL	DOCUMENT ID	REV.	LANG.	PAGE
Preliminary datasheet	Public	5SET 0540T1800, TS - MT/338/19 Jun-21	A	en	7/7